

**MISUTONIDA**  
italian style  
accessories **4X4**



**EC Type Approval Certificate**  
**Certificato d'omologazione Europea**  
**Certifié d'homologation Européenne**

**EC Approved Ø 63mm Frontal System**  
**Protezione Anteriore Ø 63mm Omologata**  
**Protection Anterieure Ø 63mm Homologuée**  
**for/per/pour**

**TOYOTA PROACE - CITROEN**  
**JUMPY - PEUGEOT EXPERT**  
**Mod.2016**

**PART**

**EC/MED/411/IX - EC/MED/414/IX**  
**EC/MED/415/IX**

**type approval n.**  
**n. di omologazione**  
**numero d'homologation**

**e9\*78/2009\*459/2011B\*1151\*01**



**Approval sign**  
**Codice di omologazione**  
**Code d'homologation**

**B e9 02 1151 Type411**



e9\*78/2009\*459/2011B\*1151\*01

Página / Page 1/4

Comunicación relativa a / Communication concerning the

- homologación-CE / EC-type-approval (1)
- extensión de la homologación CE / extension of EC type-approval (1)
- denegación-de-homologación-CE / refusal-of-EC-type-approval (1)
- retirada-de-homologación-CE / withdrawal-of-EC-type-approval (1)

respecto a un sistema de protección delantera que deba suministrarse como unidad técnica independiente / of a type of frontal protection system to be supplied as a separate technical unit

De conformidad con el reglamento (CE) nº 78/2009 del Parlamento Europeo y del Consejo, de 14 de enero de 2009, aplicado por / with regard to Regulation (EC) No 78/2009 of the European Parliament and of the Council of 14 January 2009 as implemented by

Y modificado por última vez por el Reglamento (CE) nº / last amended by Regulation (EC) No 631/2009(2)

Nº de homologación / Type approval number: e9\*78/2009\*459/2011B\*1151\*01

Motivos de la extensión / Reasons for the extension: Ver informe PC16100019 / See report PC16100019.

#### SECCIÓN I / SECTION I

- 0.1. Marca (razón social del fabricante) / Make (trade name of manufacturer): MISUTONIDA
- 0.2. Tipo / Type: 411
- 0.3. Medio de identificación del tipo de vehículo, si está marcado en este / Means of identification of type, if marked on the vehicle (3): Ver documentación aportada por el fabricante / See technical documentation supplied by the manufacturer.
- 0.3.1. Ubicación de esa marca / Location of that marking: Ver documentación aportada por el fabricante / See technical documentation supplied by the manufacturer
- 0.5. Nombre o razón social y domicilio del fabricante / Name and address of manufacturer:

MACH, S.R.L.  
Via Fondovalle 3  
12062 CHERASCO (CN)  
ITALIA

- 0.7. Emplazamiento y forma de colocación de la marca de homologación CE / Location and method of affixing of the EC type-approval mark: Ver documentación aportada por el fabricante / See technical documentation supplied by the manufacturer.

- 0.8. Nombre(s) y dirección(es) de la(s) planta(s) de montaje / Names and address(es) of assembly plant(s):

MACH, S.R.L.  
Via Fondovalle 3  
12062 CHERASCO (CN)  
ITALIA

---

(1) Táchese lo que no proceda / Delete where not applicable  
(2) Insértese el número de Reglamento modificador / Insert number of amending Regulation  
(3) Si el medio de identificación del tipo contiene caracteres no pertinentes para la descripción del vehículo, la unidad técnica independiente o el componente a que se refiere esta información, tales caracteres se sustituirán en el documento por el símbolo "?": / If the means of identification of type contains characters not relevant to describe the vehicle, component or separate technical documentation unit types covered by this information, such characters shall be represented in the documentation by the symbol "?".



MINISTERIO  
DE INDUSTRIA, ENERGÍA  
Y TURISMO

DIRECCIÓN GENERAL DE INDUSTRIA Y  
DE LA PEQUEÑA Y MEDIANA EMPRESA  
SUBDIRECCIÓN GENERAL DE  
CALIDAD Y SEGURIDAD INDUSTRIAL

e9\*78/2009\*459/2011B\*1151\*01

Página / Page 2/4

0.9 Nombre y domicilio del representante del fabricante (si procede) / *Name and address of the manufacturer's representative (if any):*

MACH, S.R.L.  
Via Fondovalle3  
I2062 CHERASCO (CN)  
ITALIA

## SECCIÓN II / SECTION II

1. Información complementaria (véase la adenda) / *Additional information (where applicable) ( see Addendum)*
2. Servicio técnico encargado de realizar los ensayos / *Technical service responsible for carrying out the tests: IDIADA*
3. Fecha del acta del ensayo / *Date of test report: 7/10/2016*
4. Número del acta del ensayo / *Number of test report: PC16090217, PC16100019*
5. Observaciones, (si las hubiera) (véase la adenda) / *Remarks (if any) (see Addendum):---*
6. Lugar / *Place: Madrid*
7. Fecha / *Date: Ver firma electrónica / See electronic signature*
8. Firma / *Signature:*

EL SUBDIRECTOR GENERAL DE CALIDAD Y SEGURIDAD INDUSTRIAL  
Resolución P.D. 25-10-2012

Se adjunta / *Attached:*

Expediente de homologación / *Homologation report*

- 
- (1) Táchese lo que no proceda / *Delete where not applicable*
  - (2) Insértese el número de Reglamento modificador / *Insert number of amending Regulation*
  - (3) Si el medio de identificación del tipo contiene caracteres no pertinentes para la descripción del vehículo, la unidad técnica independiente o el componente a que se refiere esta información, tales caracteres se sustituirán en el documento por el símbolo "?". / *If the means of identification of type contains characters not relevant to describe the vehicle, component or separate technical documentation unit types covered by this information, such characters shall be represented in the documentation by the symbol "?".*



e9\*782009\*4592011B\*1151\*01

Página / Page 3/4

Adenda al certificado de homologación CE nº e9\*782009\*4592011B\*1151\*01 sobre la homologación de un vehículo en lo referente a la protección de los peatones conforme al Reglamento (CE) nº 78/2009  
*Addendum to EC type-approval certificate No e9\*782009\*4592011B\*1151\*01 concerning the type-approval of a vehicle with regard to pedestrian protection with regard to Regulation (EC) No 78/2009*

**1. Información adicional / Additional information**

- 1.1. Método de acoplamiento / Method of attachment: Mediante tornillos / With screws.
- 1.2. Instrucciones de montaje e instalación / Assembly and mounting instructions: Ver documentación aportada por el fabricante / See technical documentation supplied by the manufacturer.
- 1.3. Lista de tipos de vehículos en los que se puede instalar el sistema, restricciones de uso y condiciones para el montaje. / List of vehicles on which the frontal protection system may be fitted, any usage restrictions and necessary conditions for fitting:

Tipo de vehículo / Type of vehicle	Denominación comercial / Commercial description	Contraseña de homologación / Approval number
V B BHXH-B2B01C(B)	TOYOTA PROACE	e2*2007/46*0538*
V B BHXH-B2B01C	CITROEN JUMPY	e2*2007/46*0531*
V F AHKH-B2A01D	PEUGEOT EXPERT	e2*2007/46*0533*

- 2. Observaciones / Remarks:---

- (1) Táchese lo que no proceda / Delete where not applicable
- (2) Insértese el número de Reglamento modificador / Insert number of amending Regulation
- (3) Si el medio de identificación del tipo contiene caracteres no pertinentes para la descripción del vehículo, la unidad técnica independiente o el componente a que se refiere esta información, tales caracteres se sustituirán en el documento por el símbolo "?". / If the means of identification of type contains characters not relevant to describe the vehicle, component or separate technical documentation unit types covered by this information, such characters shall be represented in the documentation by the symbol "?".



e9\*78/2009\*459/2011B\*1151\*01

Página / Page 4/4

3. Resultados de los ensayos con arreglo a los requisitos del anexo 1, sección 5, del Reglamento (CE) nº 78/2009 / Test results according to the requirements of Section 5 of Annex 1 to Regulation (EC) No 78/2009

Ensayo / Test	Valores registrados / Values recorded		Superado/Pass / No superado/fail
	Ángulo de flexión / Bending angle	9.32 grados/degrees 1.27 grados/degrees 1.05 grados/degrees	
Parte inferior de la pierna-sistema de protección delantera / lower legform to frontal protection system  3 posiciones de ensayo / 3 test positions (en su caso) / (where performed)	Desplazamiento de rotura / Shear displacement	4.37 mm 3.82 mm 3.21 mm	Superado/Pass
	Acceleración en tibia / Acceleration at tibia	140.52g 157.93 g 117.94 g	Superado/Pass
	Suma de las fuerzas de impacto / Sum of impact forces	---	No procede / does not apply
Parte superior de la pierna-Sistema de protección delantera / Upper legform to frontal protection system  3 posiciones de ensayo / 3 test positions (en su caso) / (where performed)	Momento de flexión / Bending moment	---	No procede / does not apply
	Suma de las fuerzas de impacto / Sum of impact forces	35.85 kN 37.91 kN	sólo observación / monitoring only
Cabeza de niño / de adulto de pequeño tamaño (3,5 kg)-Sistema de protección delantera / Child/adult adult headform (3,5 kg) to frontal protection system	Momento de flexión / Bending moment	531.4 Nm 693.8 Nm	sólo observación / monitoring only
	Valores HPC (al menos 3 valores) / HPC values (at least 3 values)	---	No procede / does not apply

- (1) Táchese lo que no proceda / Delete where not applicable
- (2) Insértese el número de Reglamento modificador / Insert number of amending Regulation
- (3) Si el medio de identificación del tipo contiene caracteres no pertinentes para la descripción del vehículo, la unidad técnica independiente o el componente a que se refiere esta información, tales caracteres se sustituirán en el documento por el símbolo "x"; / If the means of identification of type contains characters not relevant to describe the vehicle, component or separate technical documentation unit types covered by this information, such characters shall be represented in the documentation by the symbol "x".

**MISUTONIDA**  
 italian style  
 accessories **4x4**

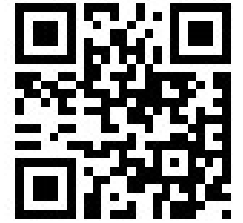

**TOYOTA PROACE, CITROEN JUMPY, PEUGEOT EXPERT**



**60 Min.**

Item Code

**EC/MED/411/IX**

Codice Articolo

**:EC/MED/414/IX**

Référence Article

**EC/MED/415/IX**

**GB**

STAINLESS STEEL  
MEDIUM BAR













**ITA**

MEDIUM BAR  
IN ACCIAIO INOX

**FR**

MEDIUM BAR  
EN ACCIER INOX

# TOYOTA PROACE, CITROEN JUMPY, PEUGEOT EXPERT

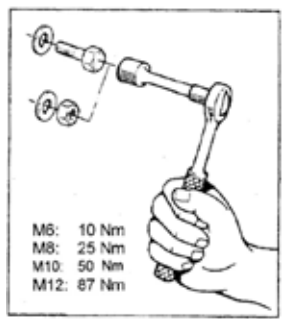
Part List Lista della bulloneria Liste des pièces				
<b>A</b>  <b>TE 8X20</b> x 6	<b>B</b>  <b>Ø 8</b> x 8	<b>C</b>  <b>Ø 8</b> x 8	<b>D</b>  <b>M 6</b> x 2	<b>E</b>  <b>TE 6X25</b> x 2
<b>F</b>  <b>Ø 6</b> BIG GRAND GRAND x 2	<b>G</b>  <b>Ø 6</b> x 2	<b>H</b>  <b>TE 8X25</b> x 2	<b>I</b>  <b>SM/411/A</b> x 2	<b>L</b>  <b>SM/411/B</b> x 1
<b>M</b>  <b>SM/411/C</b> x 2	 <b>Cappelletti M8</b> x 4			
				 <p>M6: 10 Nm M8: 25 Nm M10: 50 Nm M12: 67 Nm</p>

**TOYOTA PROACE, CITROEN JUMPY, PEUGEOT EXPERT**

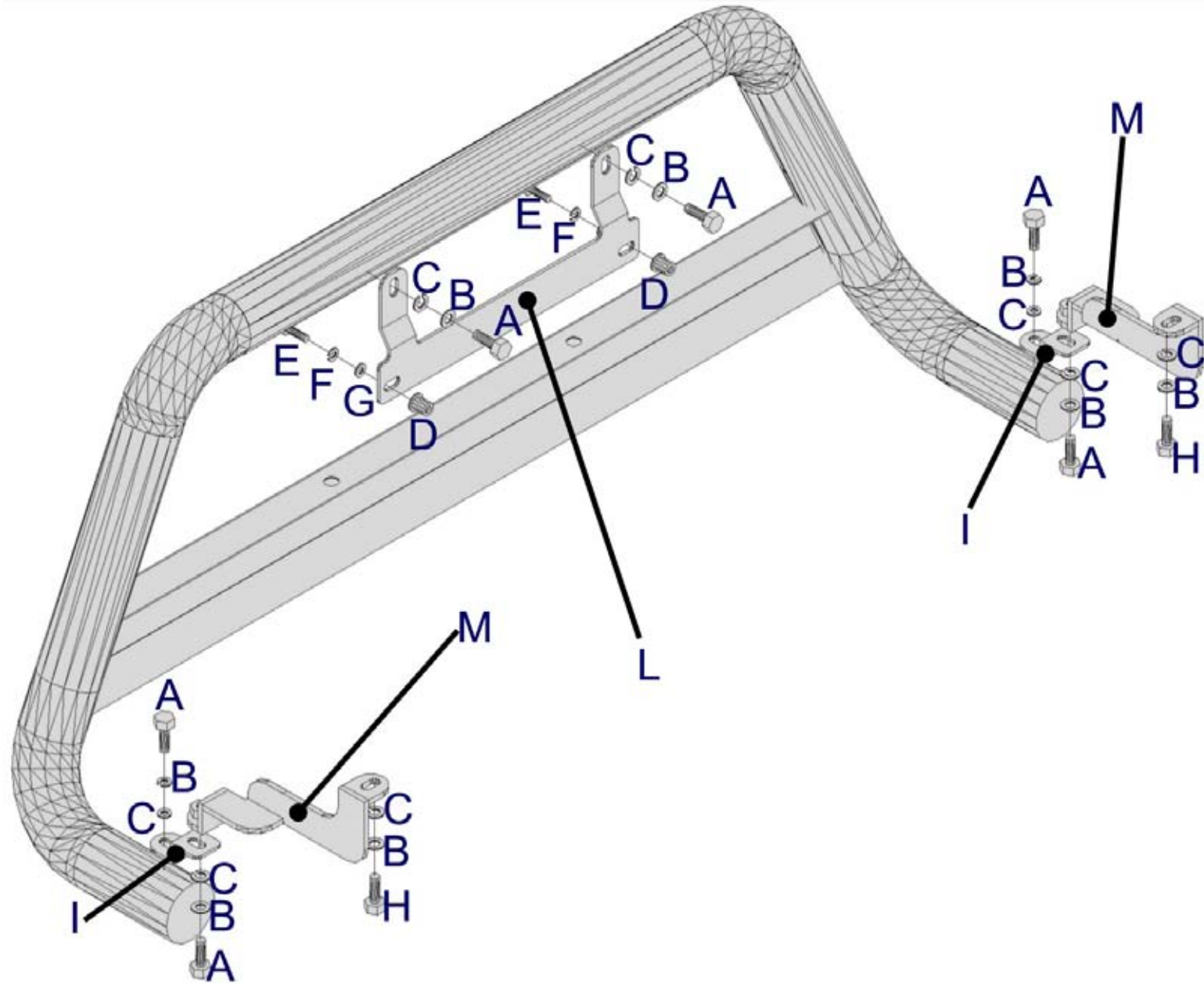



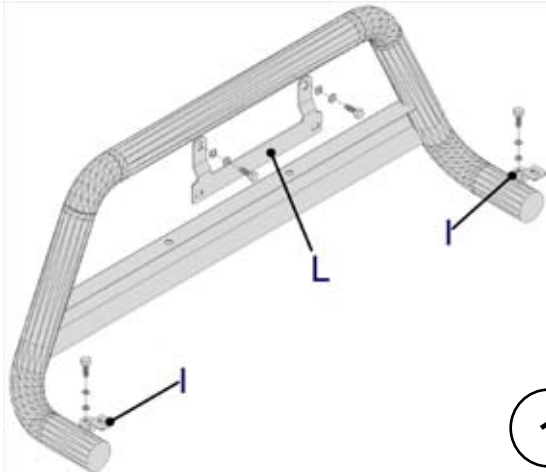

1



2



3



4



5



6

Date Data Date	Item Code Cod.Articolo Réf. Article	Vehicle model Modello Veicolo Modèle de Voiture
06/10/16	EC/MED/411/IX EC/MED/414/IX EC/MED/415/IX	TOYOTA PROACE, CITROEN JUMPY, PEUGEOT EXPERT

**MISUTONIDA**  
italian style accessories **4x4**

Document checked and approved by  
**Documento controllato ed approvato da**  
 Document contrôlé et approuvé par

**BOTTA PIETRO**

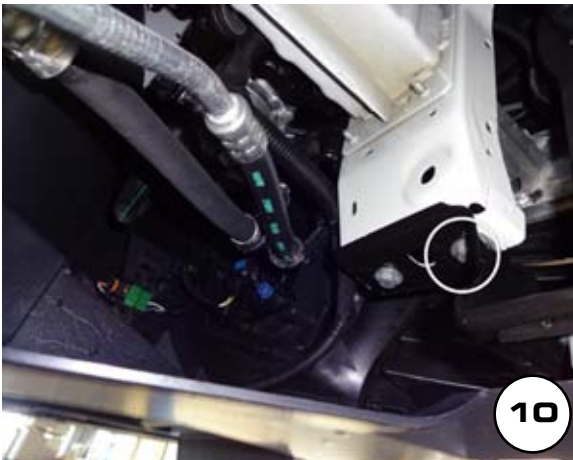

Date Data Date	Item Code Cod.Articolo Réf. Article	Vehicle model Modello Veicolo Modèle de Voiture
06/10/16	EC/MED/411/IX EC/MED/414/IX EC/MED/415/IX	TOYOTA PROACE, CITROEN JUMPY, PEUGEOT EXPERT

Document checked and approved by  
**Documento controllato ed approvato da**  
 Document contrôlé et approuvé par

**BOTTA PIETRO**

**MISUTONIDA**  
 italian style accessories **4x4**



## TOYOTA PROACE



Date Data Date	Item Code Cod.Articolo Réf. Article	Vehicle model Modello Veicolo Modèle de Voiture
06/10/16	EC/MED/411/IX EC/MED/414/IX EC/MED/415/IX	TOYOTA PROACE, CITROEN JUMPY, PEUGEOT EXPERT

**MISUTONIDA**  
italian style accessories **4x4**

Document checked and approved by  
Documento controllato ed approvato da  
Document contrôlé et approuvé par

**BOTTA PIETRO**



Date Data Date	Item Code <b>Cod.Articolo</b> Réf. Article	Vehicle model <b>Modello Veicolo</b> Modèle de Voiture
<b>06/10/16</b>	<b>EC/MED/411/IX EC/MED/414/IX EC/MED/415/IX</b>	<b>TOYOTA PROACE, CITROEN JUMPY, PEUGEOT EXPERT</b>

Document checked and approved by  
**Documento controllato ed approvato da**  
 Document contrôlé et approuvé par

**BOTTA PIETRO**